

INTRODUCTION TO DIGITAL COMMUNICATION

ECE 426– DIGITAL COMMUNICATION

Monday, 16 February 2026

Polite Reminder – Bloom's Taxonomy

We are NOT Teaching Remembering and Understanding Only...

Bloom's Taxonomy

Creating:

Can students create a new product or point of view?
They would be able to assemble, construct, create, design, develop, formulate, write, or invent.

Evaluating:

Can the student justify a stand or decision?
To evaluate information, a student might: appraise, argue, defend, judge, select, support, value, and evaluate.

Analyzing:

Can the student distinguish between the different parts?
They would be able to compare, contrast, criticize, differentiate, discriminate, distinguish, examine, experiment, question, or test.

Applying:

Can the student use the information in a new way?
They would be able to choose, demonstrate, dramatize, employ, illustrate, interpret, operate, sketch, solve, use, or write.

Understanding:

Can the student explain ideas or concepts?
They would be able to classify, describe, discuss, explain, identify, locate, recognize, report, select, translate, or paraphrase.

Remembering:

Can the student recall or remember the information?
They would be able to define, duplicate, list, memorize, recall, repeat, reproduce, or state.

A Student

B Student

C Student

D Student

EEEN 464: DIGITAL COMMUNICATION SYSTEMS (L: 30/P: 30/CF: 3.0) Y4S2

Pre-requisites: EEEN 462: ANALOGUE COMMUNICATION SYSTEMS

Course content

Pulse Modulation: PCM, DPCM, DM, PWM, PPM, PAM. Quantization noise in PCM SNR in PCM baseband systems. Digital Data Transmission: The optimum linear filter. Transmission of data over vector channels. Baseband and pass band data transmission; digital carrier modulation (ASK, PSK, FSK etc), Correlation direction and matched filters.

Instruction method

Lectures: 2 hours per week; Tutorial: 2 hours per week, Laboratory Exercises: At least Three Four experiments per semester with each practical session 3 hours long

Assessment

Regular Examination at end of Semester: 70 %, Continuous Assessment: 30 %.

Core reading Materials |

1. Stevan Berber, (2021) Discrete Communication Systems. ISBN 9780198860792
2. Reuben Parker (2020) Electronic Communication Systems ISBN 9781682857700
3. John W. [Leis](#)(2018) Communication Systems Principles Using MATLAB ISBN 9781119470670
4. Muhammad Ali Imran [etal.](#) (2019) Enabling 5G Communication Systems to Support Vertical

Pre-requisites: ECE 328 - Principles of Communication Systems

Course Purpose:

To enable students understand the fundamental principles of digital transmission systems as used in fixed and mobile telephony, wired and wireless computer networks, data storage and digital broadcasting.

Expected Learning Outcomes:

At the end of the course, students will be able to:

- (i) describe binary and duo binary pulse Amplitude Modulation (PAM);
- (ii) design digital coding schemes;
- (iii) derive error performance equations for digital modulation schemes(ASK,FSK,PSK,DPSK);
- (iv) state strengths and weaknesses of M-ary PSK with QAM signaling schemes;
- (v) design a basic digital communication systems.

Course Content:

Signal digitization: Pulse Amplitude Modulation (PAM), sampling theorems and sampling circuits, Pulse code modulation (PCM). Quantization and signal conditioning: Uniform and non-uniform quantization; companding methods; vocoders; signal-to- quantization noise ratio. Waveform coding: Pulse transmission, PCM, Pulse-shaping; Delta modulation; adaptive delta modulation; Differential Pulse Code Modulation (DPCM), M-ary encoding. Digital Modulation: Amplitude shift keying (ASK), Frequency Shift Keying (FSK), Phase Shift Keying (PSK), Quadrature Amplitude Modulation (QAM) and Differential Phase Shift Keying (DPSK). Signal recovery in ASK, FSK and PSK; Gaussian Minimum Shift Keying (GMSK); Performance comparison. Information theory: information sources, entropy, channel capacity; Source Coding; entropy coding. Error control: Error control coding techniques; Transmission errors; Error detection methods; intersymbol interference and the eye pattern; Linear block codes; Cyclic codes; convolution codes. Multiplexing: Frequency division multiplex (FDM), Time Division Multiplexing (TDM), plesiochronous digital hierarchy (PDH). Spread spectrum communication: Direct sequence and frequency hopping methods; synchronization, spreading codes and their generation. Data transmission: Local data transmission protocols (Ethernet, token ring); Modems; high Asymmetric Digital subscriber line (ADSL); Very-high Speed Digital subscriber line (VDSL), integrated services digital network (ISDN).

EEEN 464 SYLLABUS(1)

Pre-requisites:

EEEN 462 – Analogue Communication Systems

Course Objective:

To enable students to understand the fundamental principles of digital transmission systems as used in fixed and mobile telephony, wired and wireless computer networks, data storage and digital broadcasting.

EEEN 464 SYLLABUS(2)

Expected Learning Outcomes:

At the end of the course, students will be able to:

- (i) describe binary and duo binary pulse Amplitude Modulation (PAM);
- (ii) design digital coding schemes;
- (iii) derive error performance equations for digital modulation schemes(ASK,FSK,PSK,DPSK);
- (iv) state strengths and weaknesses of PSK, M-ary, QAM;
- (v) design a basic digital communication systems.

EEEN 464 SYLLABUS(3)

(1) Signal digitization: Pulse Amplitude Modulation (PAM), sampling theorems and sampling circuits, Pulse code modulation (PCM). Quantization and signal conditioning: Uniform and non-uniform quantization; companding methods; vocoders; signal-to-quantization noise ratio.

(2) Waveform coding: Pulse transmission, PCM, Pulse shaping; Delta modulation; adaptive delta modulation; Differential Pulse Code Modulation (DPCM), M-ary encoding. Digital Modulation: Amplitude shift keying (ASK), Frequency Shift Keying (FSK), Phase Shift Keying (PSK), Quadrature Amplitude Modulation (QAM) and Differential Phase Shift Keying (DPSK). Signal recovery in ASK, FSK and PSK; Gaussian Minimum Shift Keying (GMSK); Performance comparison.

EEEN 464 SYLLABUS(4)

(3) Information theory: information sources, entropy, channel capacity; Source Coding; entropy coding.

(4) Error control: Error control coding techniques; Transmission errors; Error detection methods; inter-symbol interference and the eye pattern; Linear block codes; Cyclic codes; convolution codes.

(5) Multiplexing: Frequency division multiplex (FDM), Time Division Multiplexing (TDM), Plesiochronous Digital Hierarchy (PDH), SONET, Synchronous Digital Hierarchy (SDH).

EEEN 464 SYLLABUS(5)

6. Spread spectrum communication: Direct sequence and frequency hopping methods; synchronization, spreading codes and their generation.

7. Data transmission: Local data transmission protocols (Ethernet, Token Ring Bluetooth, WiFi); Modems; high Asymmetric Digital subscriber line (ADSL); Very-high Speed Digital subscriber line (VDSL), integrated services digital network (ISDN).

RECOMMENDED BOOKS

1. Sklar, *Digital Communications*, Prentice Hall, ISBN-10: 0130847887.
2. L. W. Couch II, *Digital and Analog Communication Systems*, 6th Ed. 2003. ISBN: 0135990289.
3. P. Lathi , Zhi Ding, *Modern Digital and Analogue Communication Systems*, 3rd Ed. Oxford University Press, ISBN-10: 0195331451

Why Digital and not analogue? /1

- 1. Quality:** Digital communication systems transmit data without distortion or loss, resulting in higher quality and clarity
- 2. Capacity:** Digital signals can carry more information than analog signals, allowing for more data storage and higher transmission rates.
- 3. Efficiency:** Digital communication systems are faster and more efficient than analog systems
- 4. Security:** Digital signals can be encrypted and protected more easily than analog signals
- 5. Flexibility:** Digital signals can be modified using programmable systems.

Why Digital and not analogue? /2

- 6. Storage:** Digital signals can be stored and retrieved accurately and inexpensively
- 7. Transmission distance:** Digital signals can be carried over longer distances using repeaters
- 8. Error correction:** Digital communication systems can quickly and easily detect and correct errors
- 9. Cost:** Digital circuits can be mass-produced at relatively low costs.

Disadvantages of Digital Communication

1. Digital communication requires more transmission bandwidth.
2. There is a requirement for synchronization.
3. There are sampling and quantization errors.
4. There is higher power consumption in digital communication systems.

BASIC COMMUNICATION CONCEPTS

EEEN 464 – Digital Communication Systems
Friday, 6 February 2026

BLOCK DIAGRAM OF BASIC ANALOG COMMUNICATION SYSTEM

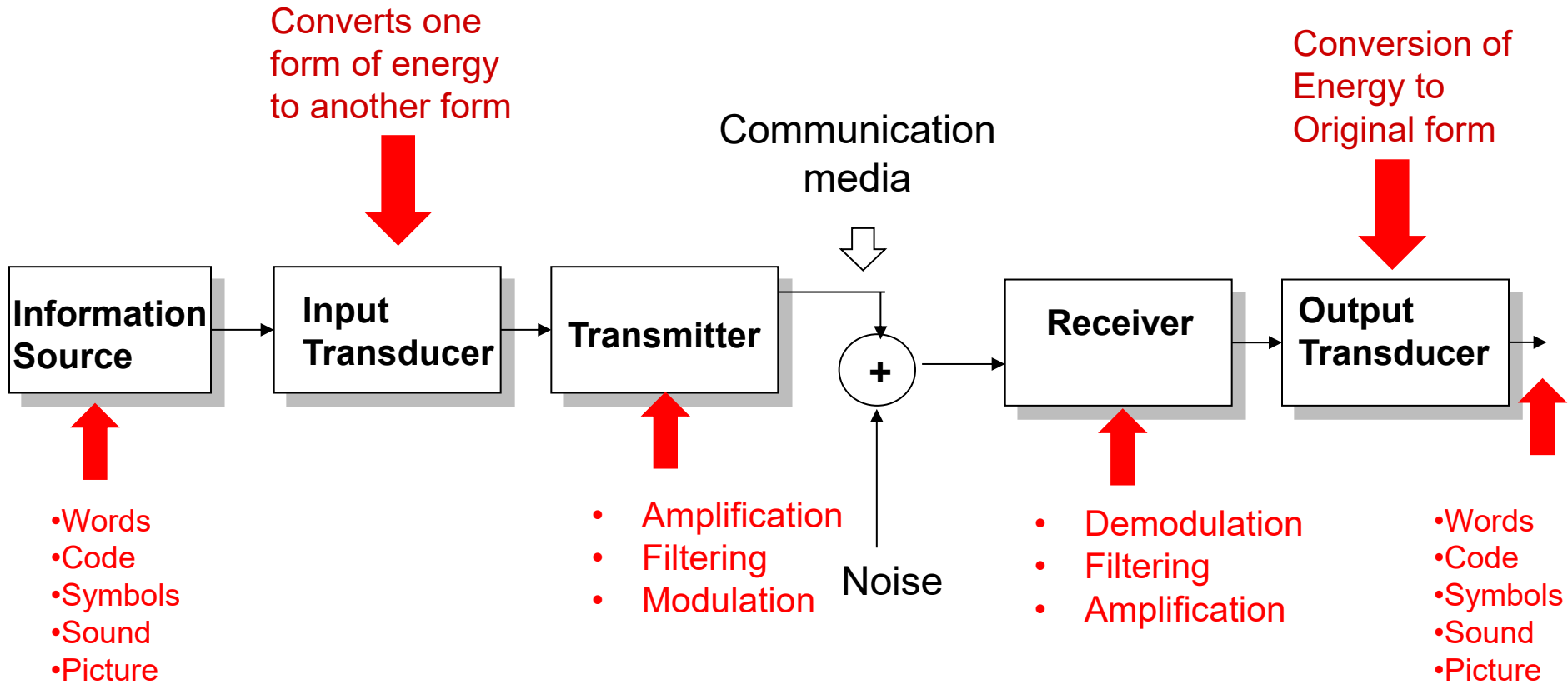

BLOCK DIAGRAM OF DIGITAL COMMUNICATION

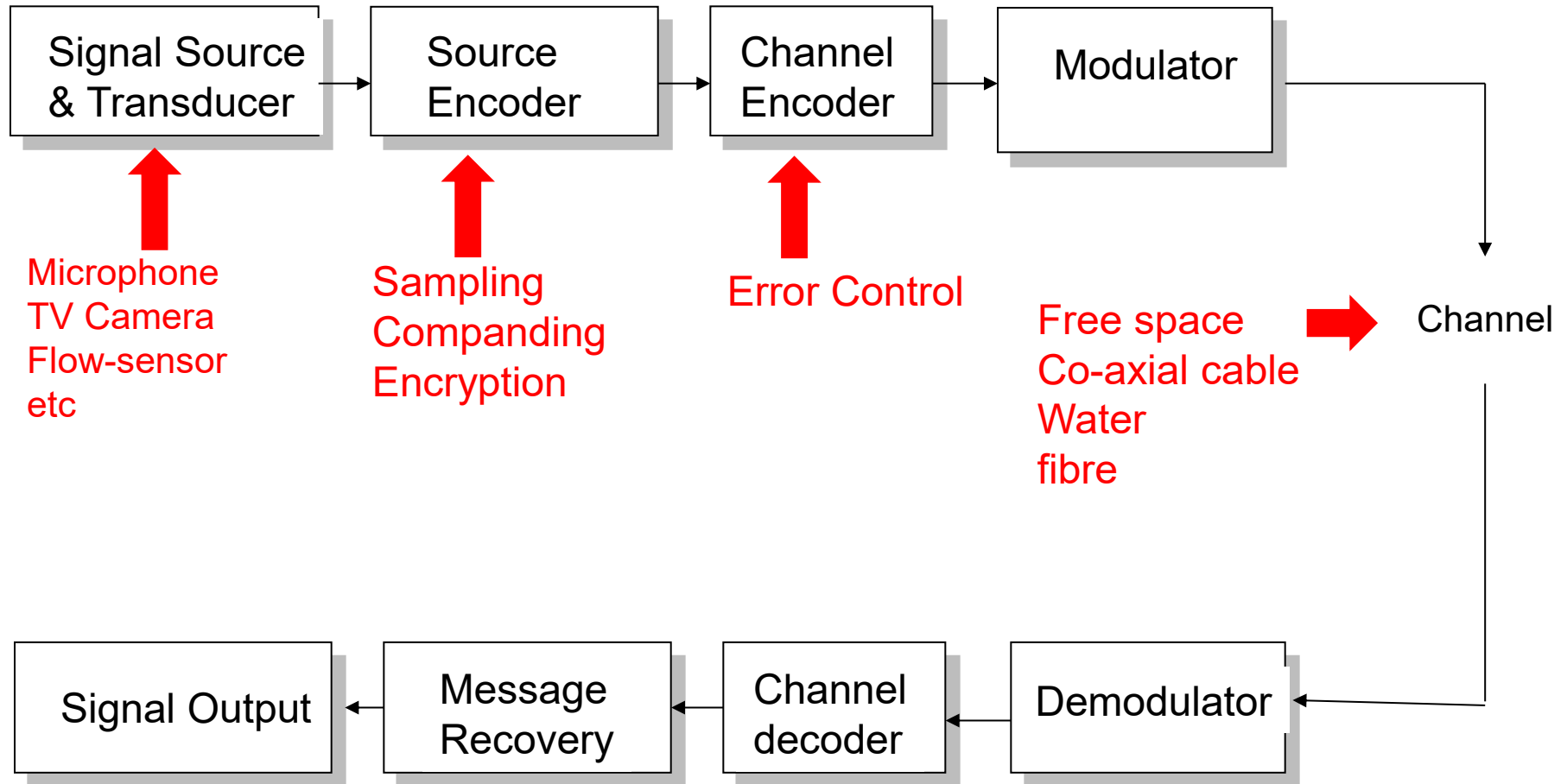

DEFINITION OF DIGITAL SIGNAL /1

A signal is described as digital when it is discrete in time and amplitude

Example of Digital signal
m-ary with $m = 2$ (binary)

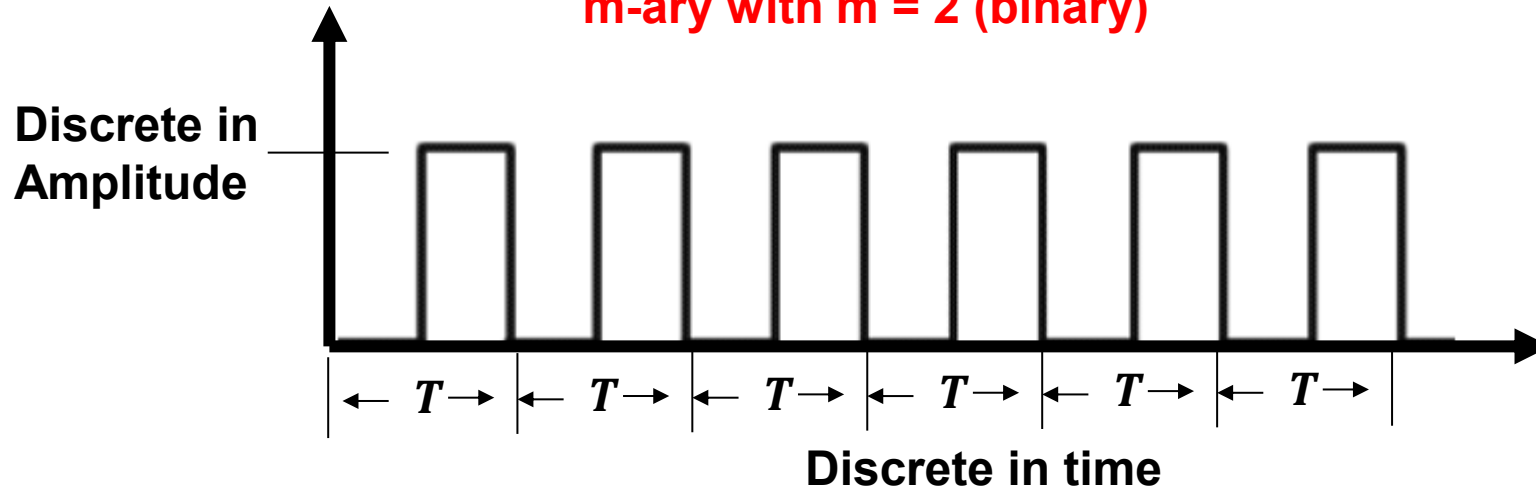

Features

A digital signal is easily represented by a computer

Digital signals can be compressed

Digital signals can include additional information for error detection and correction

DEFINITION OF DIGITAL SIGNAL /2

A signal is described as digital when it is discrete in time and amplitude.

Example of Digital signal m-ary with $m = 4$ (Quaternary)

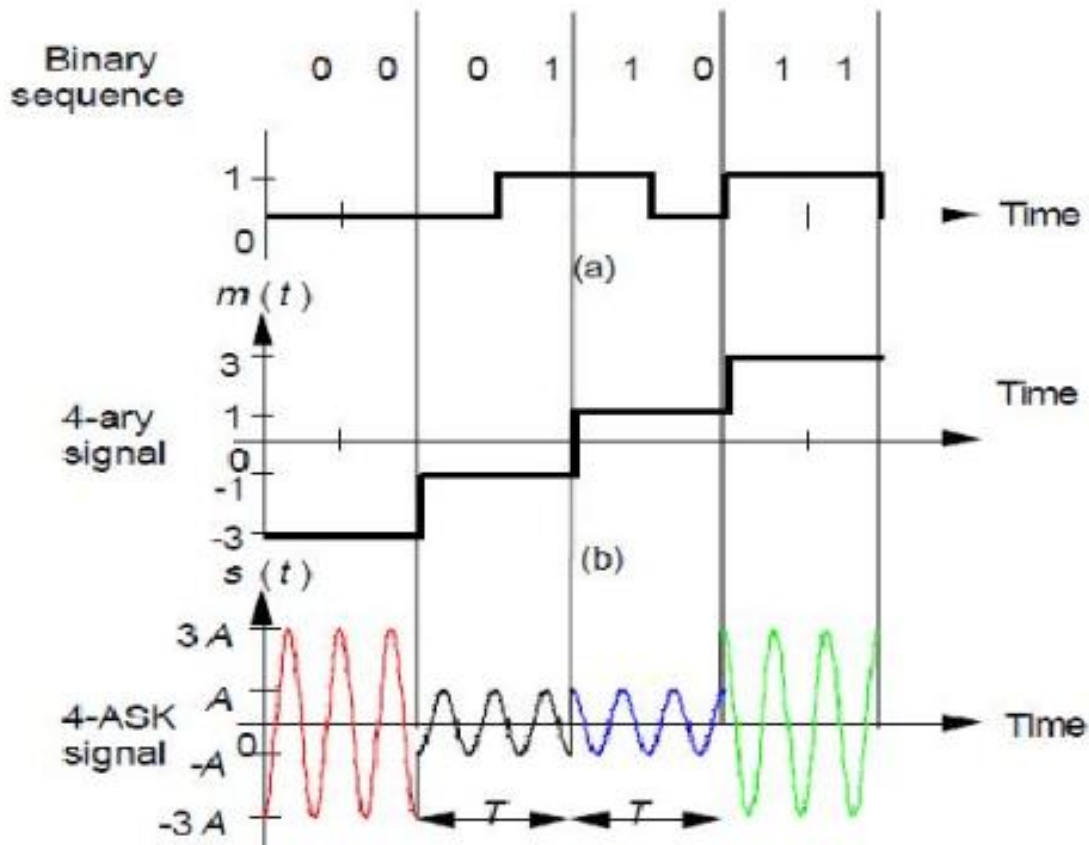

SAMPLING & CODING (1)

Quantizing

Converting amplitude into discrete levels,
Generally 2^n quantization levels

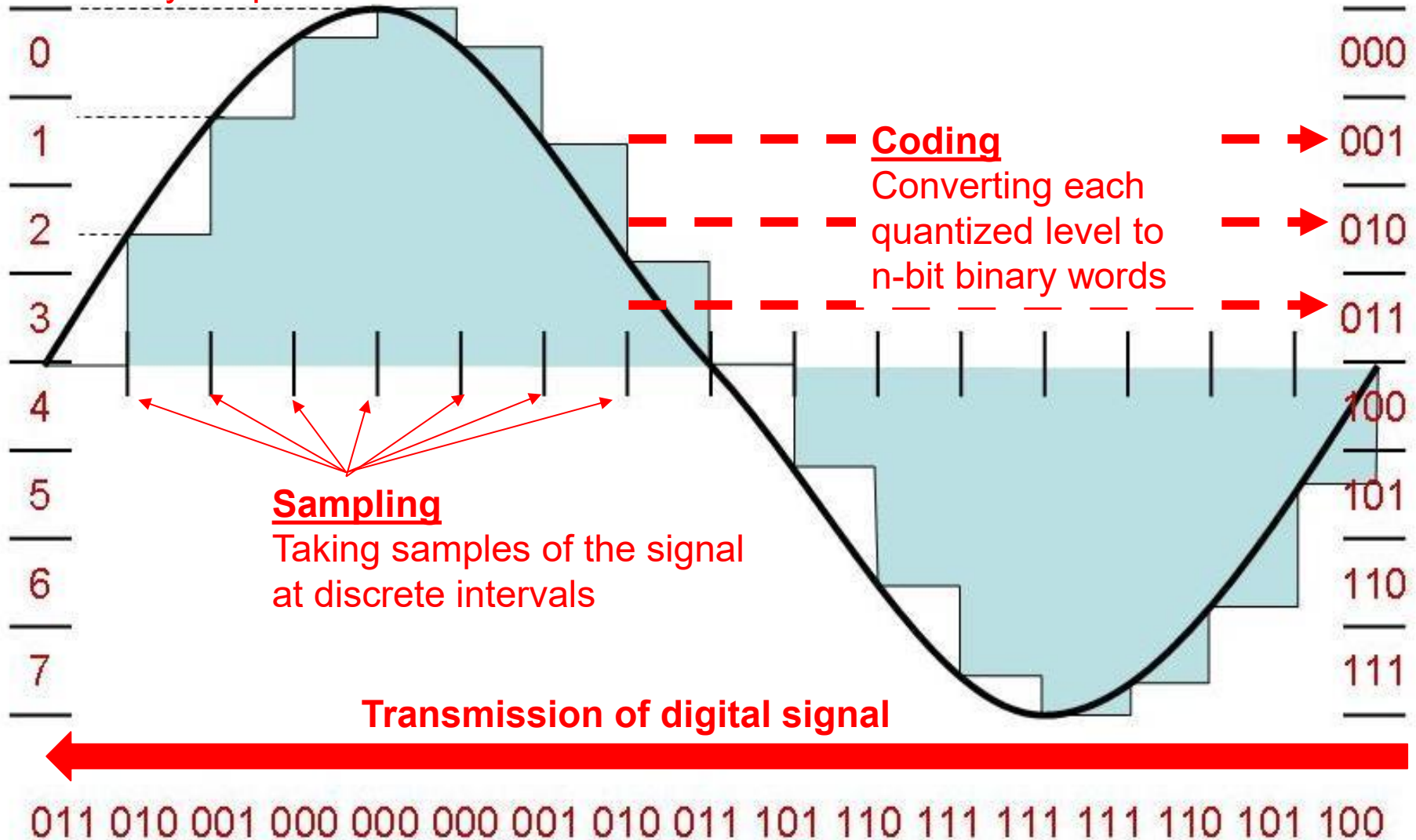

ANALOGUE TO DIGITAL CONVERTERS

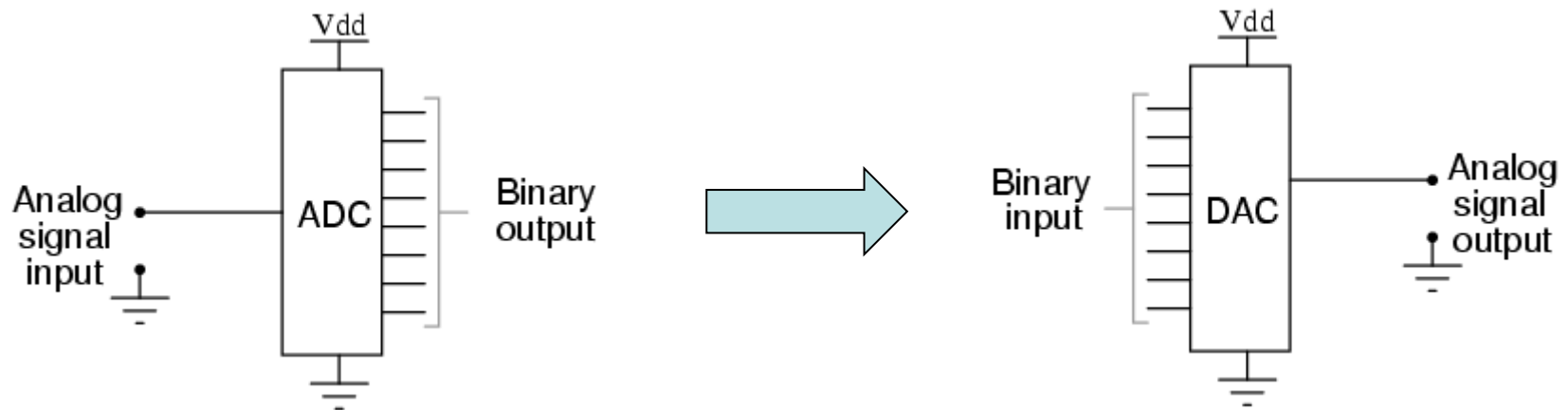

- 1. Analog to Digital Converter (ADC)** converts an analog signal (continuous in time & amplitude) to a digital signal (discrete in time & amplitude).
- 2. Discretization** in time is called sampling
- 3. Discretization** in amplitude is called quantization.
- 4. So essentially, ADC is a combination of the following:**
 - 1. Sampler**
 - 2. Quantizer**
 - 3. Coder**

UNIFORM Vs NON-UNIFORM SAMPLING

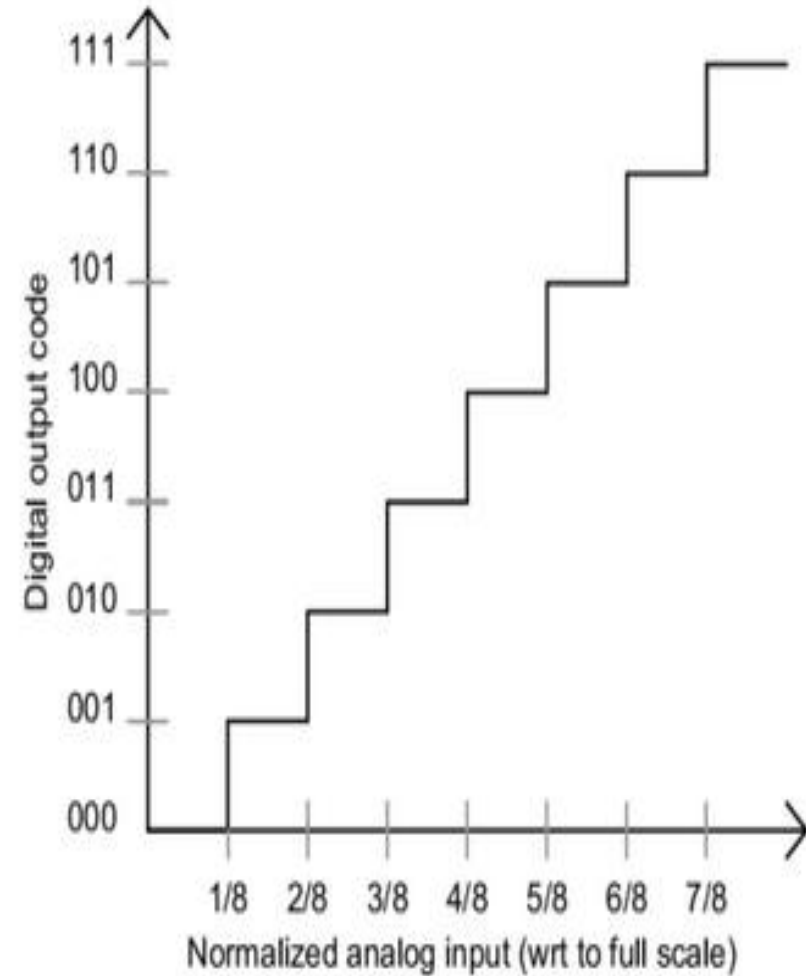

Uniform Sampling

Signal is sampled at a uniform sampling intervals

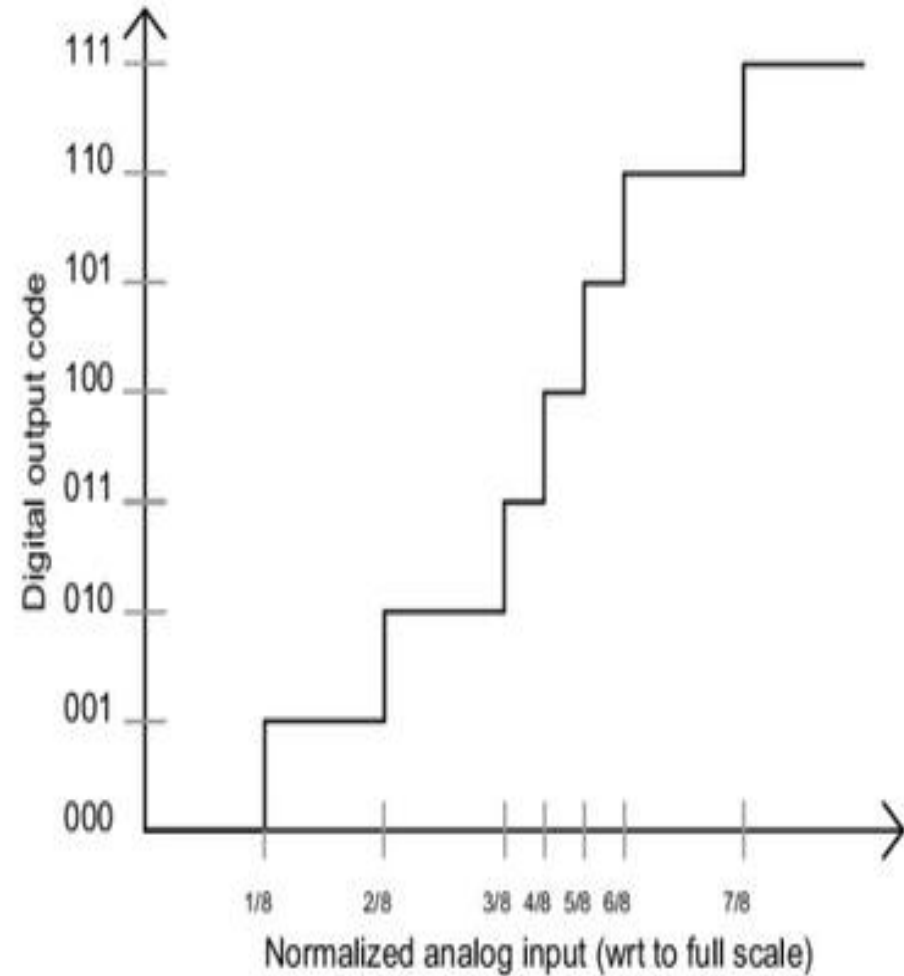

Nonuniform (multirate) Sampling

Sampling interval depends on the rate at which the amplitude varies.

RECAP OF BASIC COMMUNICATION CONCEPTS

Sources of Information

- Speech (Mic)
- Music (Mic + Instruments)
- Pictures (Camera)
- Data (Computer/Sensors)

Types of Signals

- One-Dimensional (Speech/Music)
- Two-dimensional (Stereo music, 2D pictures, etc)
- Three Dimensional (3D video, etc)

BASIC CONCEPTS

Communication Cables (Copper/Optical)

- Analogue Telephone cables (300Hz – 3.4KHz)
- Coaxial
- Optical

Wireless/Free space propagation

- Bluetooth, Zigbee, WiFi, WiMax
- Terrestrial wireless telephony – 2G (GSM), 3G (WCDMA), 4G (LTE), 5G (IMT 2020)
- Free-to-air broadcasting (voice/video) - Analogue and digital radio and TV.

BASIC CONCEPTS

MODULATION

- **Continuous-wave modulation**
 - Amplitude Modulation
 - Angle Modulation
 - Frequency Modulation
 - Phase Modulation
- **Pulse Modulation**
 - Pulse Amplitude Modulation
 - Pulse Duration Modulation
 - Pulse Position Modulation
- **Pulse Code Modulation**

DIGITAL COMMUNICATION SYSTEMS IN INDUSTRY

EEEN 464 – DIGITAL
COMMUNICATION

Friday, 6 February 2026

APPLICATIONS OF COMMUNICATION ENGINEERING

- **Communication engineering** is used in almost all industries, including aviation, manufacturing, and defense.
- **Communication engineers** design, develop, and maintain communication systems and equipment.

COMMUNICATION SYSTEMS IN THE WORKPLACE

- **Ethernet** is a Local Area Network (LAN) technology that connects network devices (such as computers, printers, etc.) via Ethernet switches and routers.
- **Industrial Ethernet** is a further development of Ethernet abilities to automation and control systems used in industrial manufacturing.
- **Profibus** is a standard for fieldbus communication in automation technology and was first promoted in 1989 by BMBF and then used by Siemens.

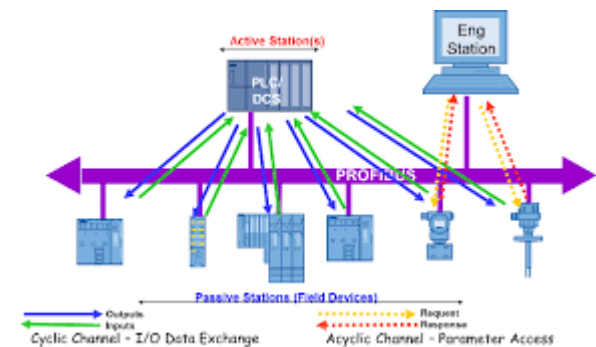
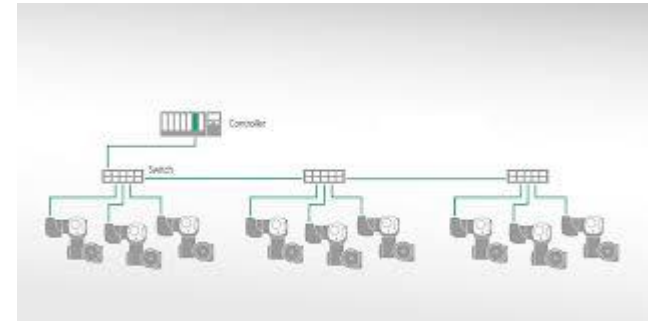

PROFIBUS / INDUSTRIAL ETHERNET

1. **Industrial Ethernet** is used in many industries for automation and control systems.
2. **Industrial Ethernet** is used to connect devices like programmable logic controllers (PLCs) and human-machine interfaces to monitor and control processes in real-time.

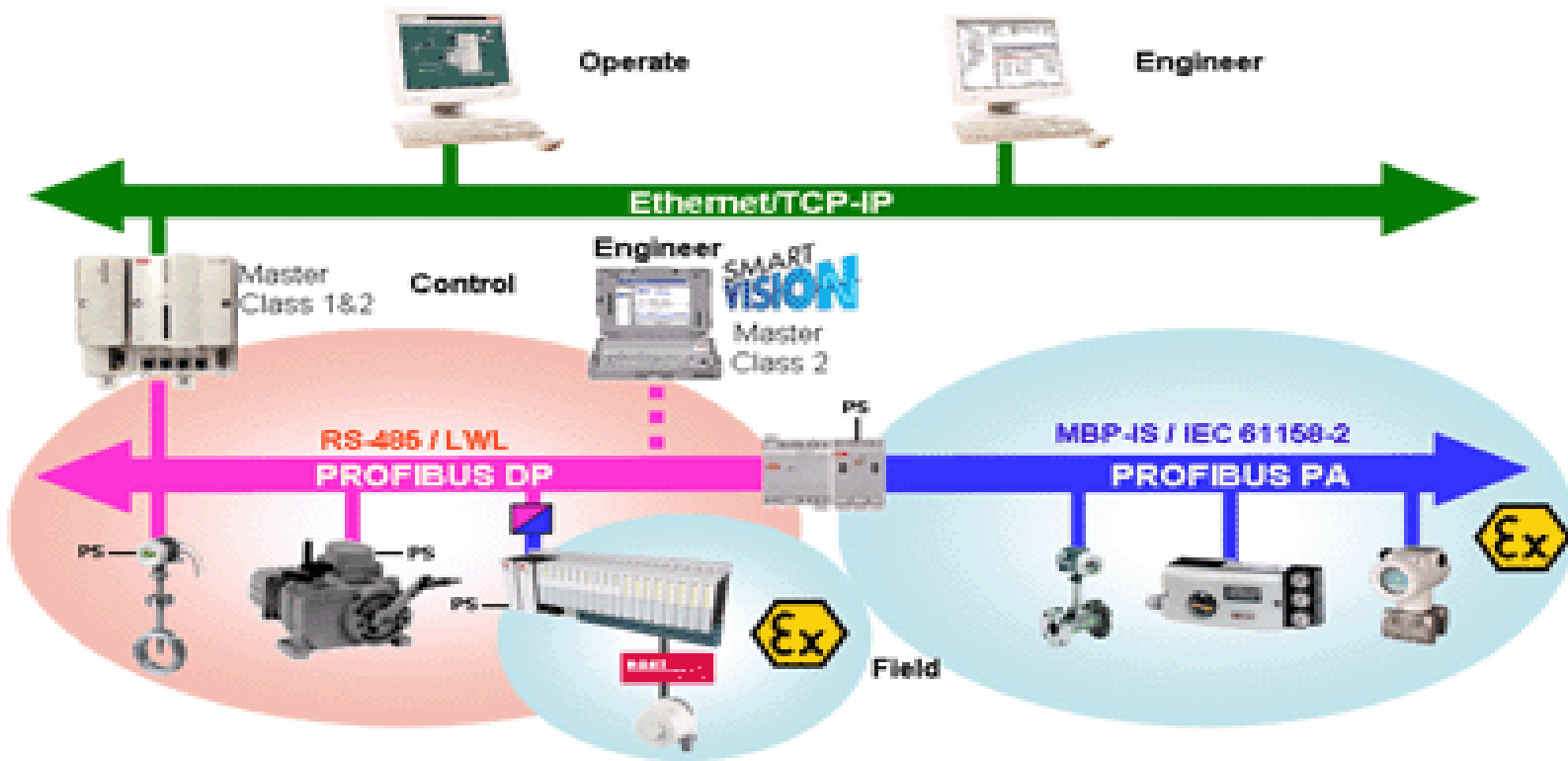

BOTTLING/CANNING PLANTS



STEEL ROLLING MILLS



GLOBAL SYSTEM FOR MOBILE COMMUNICATION

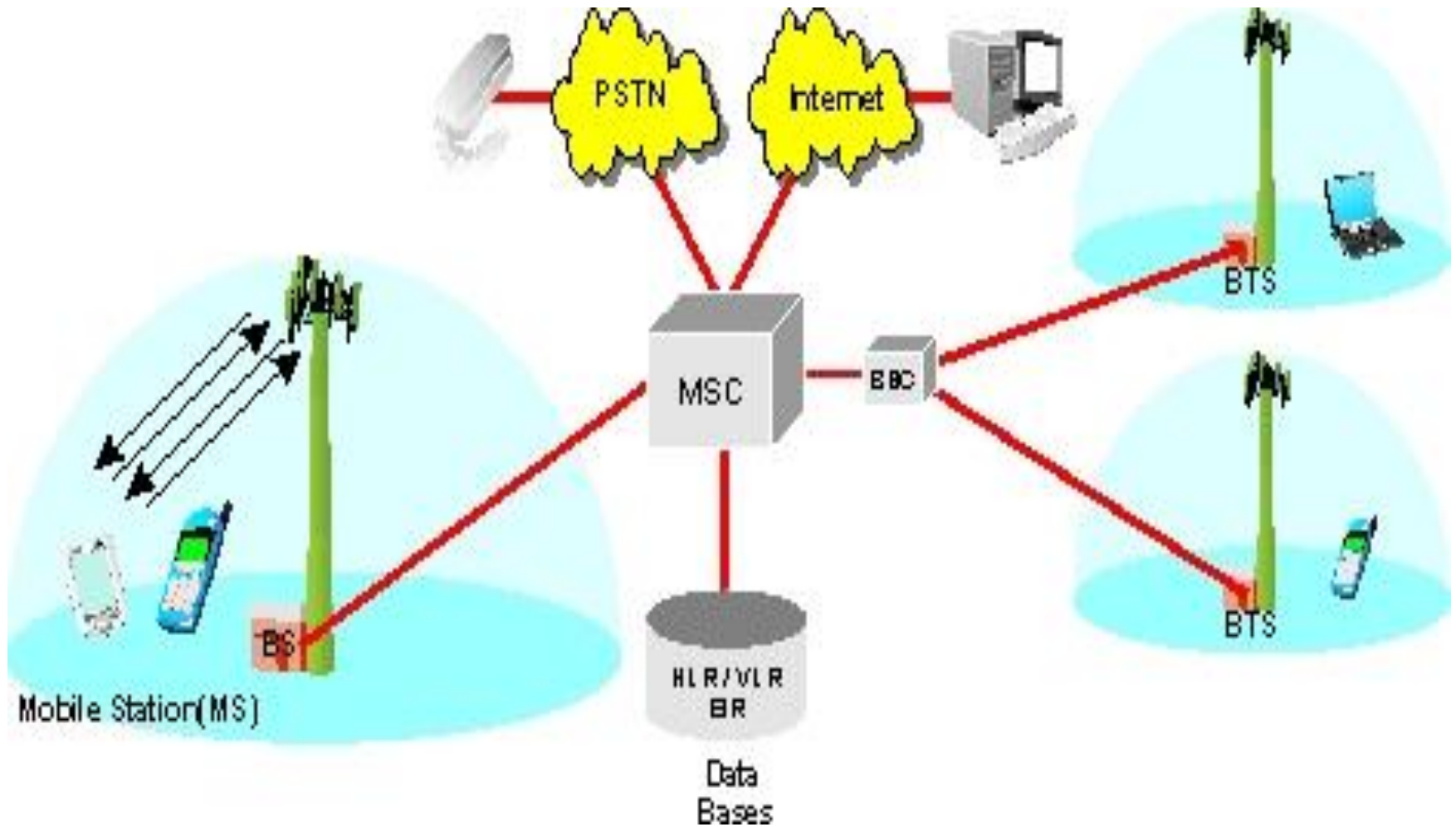

GLOBAL SYSTEM FOR MOBILE COMMUNICATION

Structure of a GSM network (key elements)

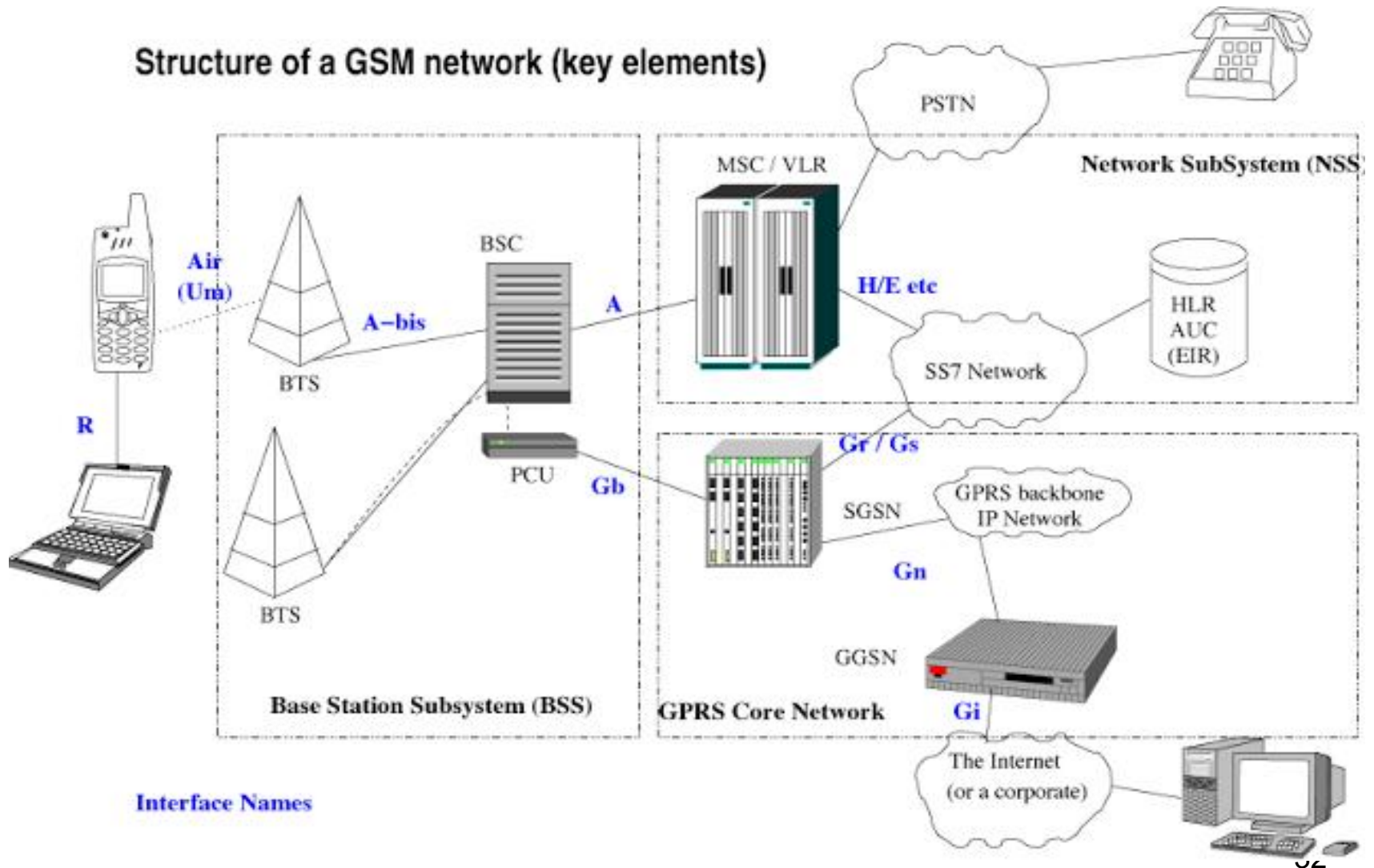

FIXED SATELLITE COMMUNICATION

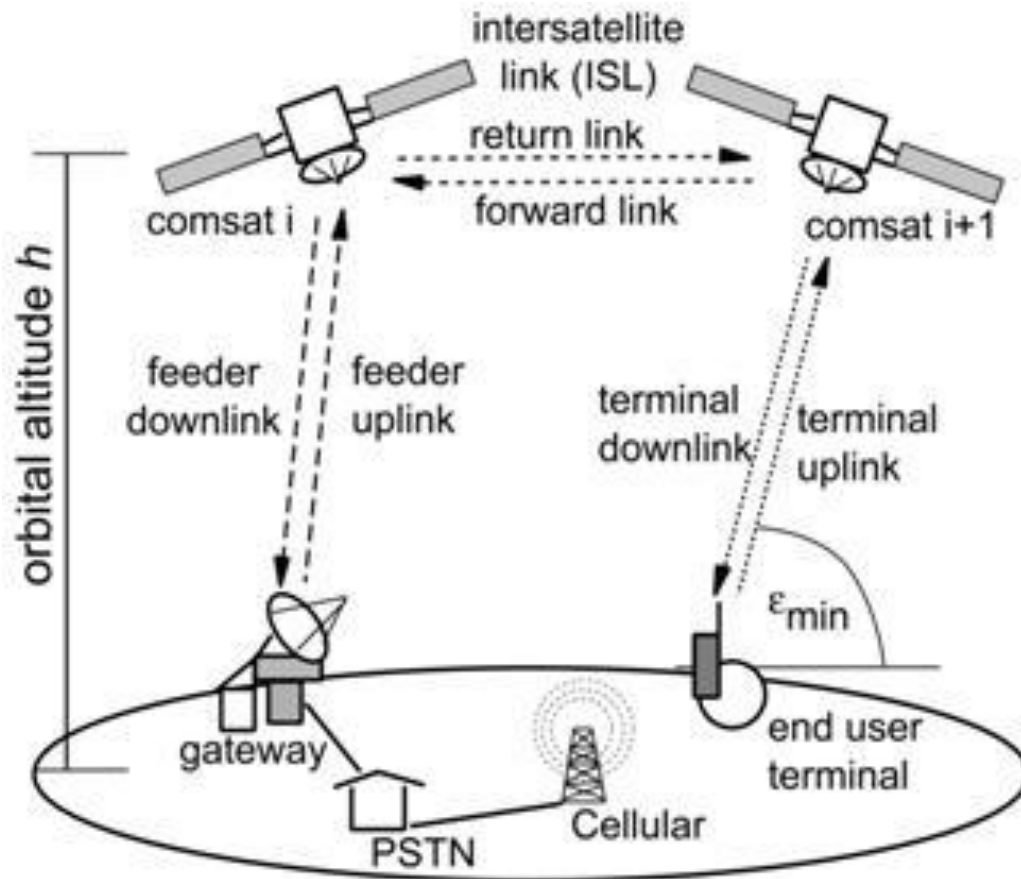

MOBILE SATELLITE COMMUNICATION

Mobile satellite communication is rendered from the radio station (earth station) installed in ground, maritime or air mobile entities (automobile, vessel, aircraft, etc.) to the other radio station (earth station) artificial satellite.

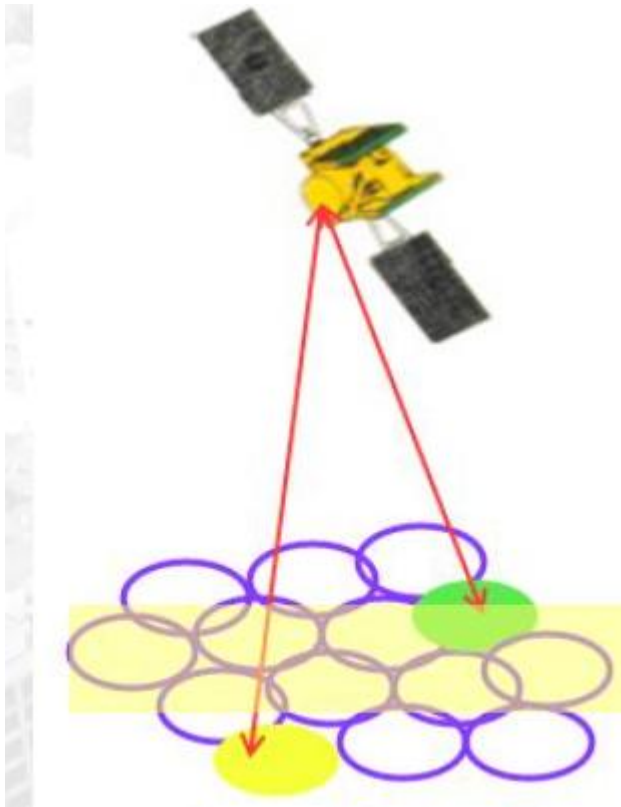





SATELLITE TELEPHONE SYSTEM/01

1. Iridium satellite constellation provides L band voice and data information coverage to satellite phones, pagers and integrated transceivers over the entire surface of Earth.
2. [Iridium Communications](#) owns and operates the constellation, additionally selling equipment and access to its services.



1. **Iridium 9575 Extreme** is the most advanced, most rugged satellite handset on the market, with the ability to locate users anywhere on the surface of the planet, precisely.
2. it provides one solution in hand for voice, data, GPS, SOS, tracking and SMS, enabling them to make the connections under the harshest conditions from the furthest reaches of the planet.
3. It is the toughest global satellite phone on the market. Iridium Extreme is also lighter, smaller and holds a longer charge than the Iridium 9555, the current gold-standard in satellite phones.

| | | | |
|--|--|--|--|
|  |  |  |  |
| Iridium 9575 Satellite Phone | Iridium 9555 Satellite Kit | Iridium Satellite Phone Gps Glob... | Iridium Extreme PTT |
| Ksh 240,000.00 | Ksh 210,000.00 | Ksh 342,711.25 ... | Ksh 260,000.00 |
| Jojabo Technolo... | Jojabo Technolo... | US\$2,650.00 + tax eBay | Jojabo Technolo... |

SATELLITE TELEPHONE SYSTEM /02

1. Thuraya is a United Arab Emirates-based regional mobile-satellite service provider.
2. Thuraya operates two geosynchronous satellites and provides telecommunications coverage in more than 161 countries in Europe, the Middle East, North, Central and East Africa, Asia and Australia.

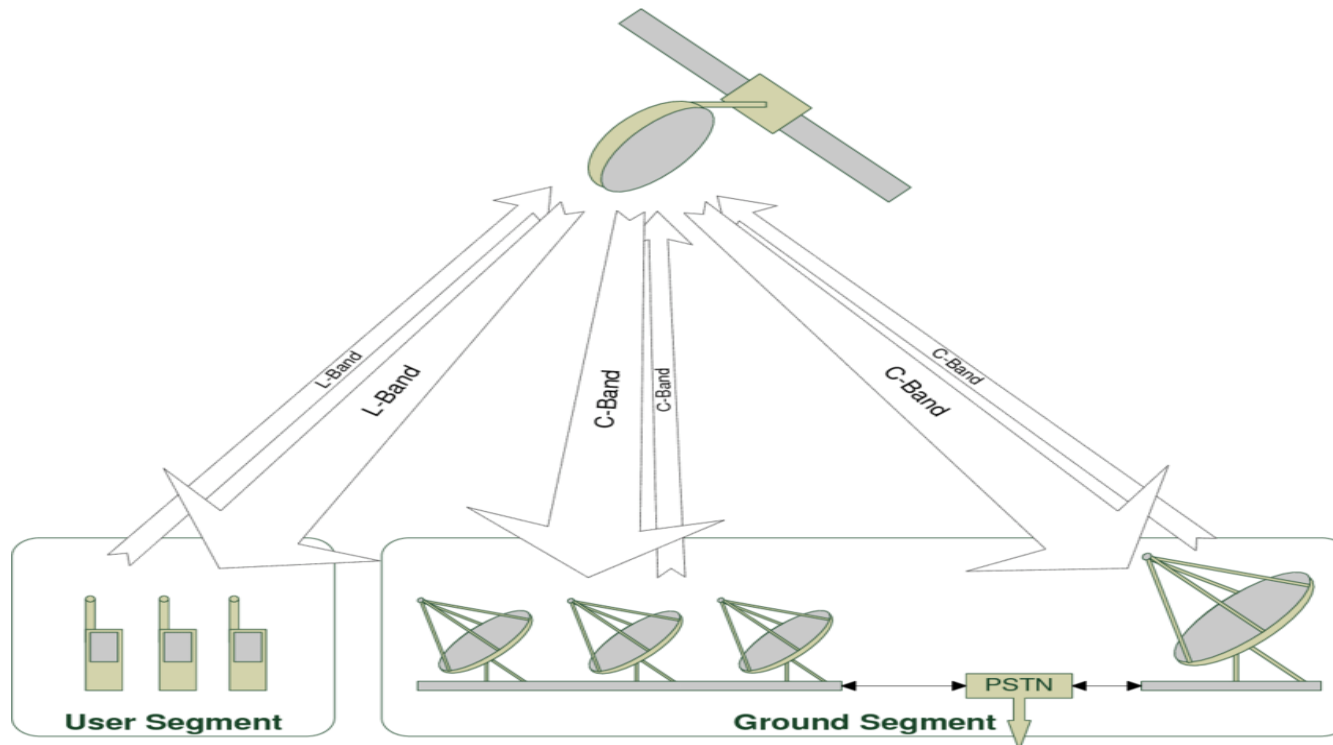

THURAYA PHONE

1. **Thuraya SatSleeve+** supports the communication needs of all smartphone users - from frequent travelers and adventurous explorers to corporate and NGO users.
2. It provides customers with access to phone calls, emails, instant messages and popular social media apps in satellite mode across Europe, Africa, Asia and Australia.
3. **SatSleeve+** comes with a universal adaptor inside the package and is compatible with various iOS and Android models.



Thuraya's XT Satellite Phone
With Hardened Gorilla Glass

Ksh 80,000.00

future technologies Ke



Thuraya XT Pro unlocked
32GB Satellite Phone

Ksh 170,000.00

Jojobo Technologies

Price for January 16, 2025

GLOBAL POSITIONING SYSTEM (GPS)

1. **Global Positioning System (GPS)** is a satellite-based radionavigation system owned by the United States government and operated by the United States Space Force.
2. It is one of the Global Navigation Satellite Systems (GNSS) that provides geolocation and time information to a GPS receiver anywhere on or near the Earth

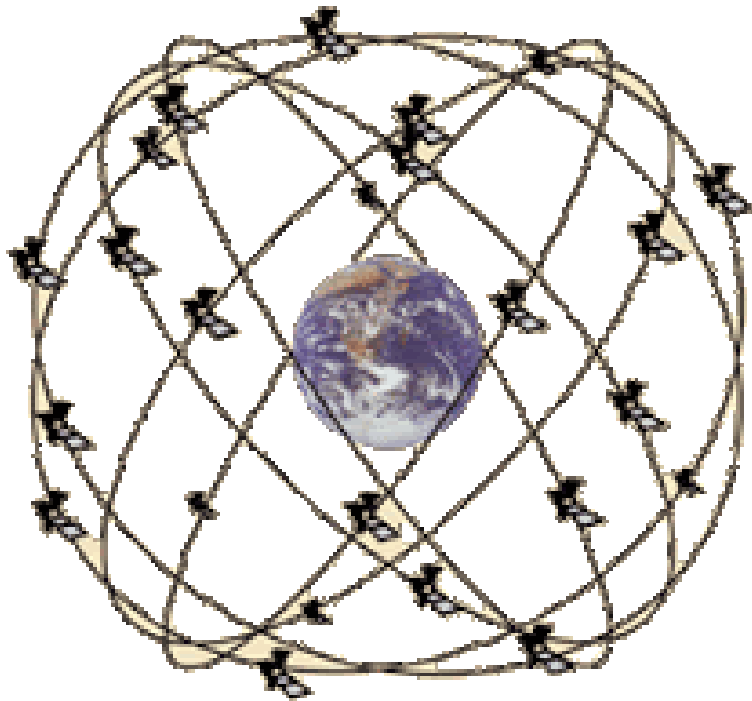

24 GPS Satellites ring the earth at 17,700 kilometers.

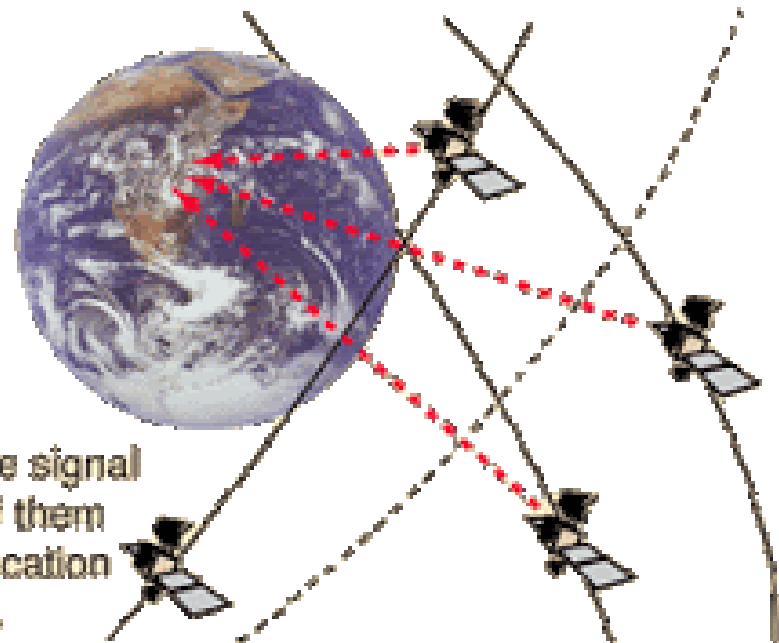

Receiving the signal from three of them gives your location on the Earth.